



7+



2



0,97m



1 = 7,4m 2 = 3,3m 3 = 3m

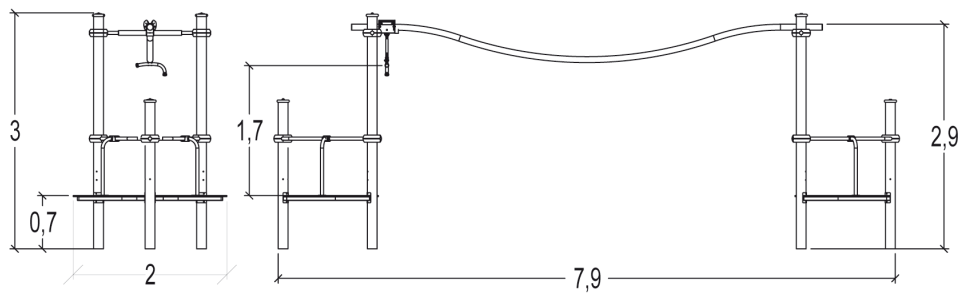
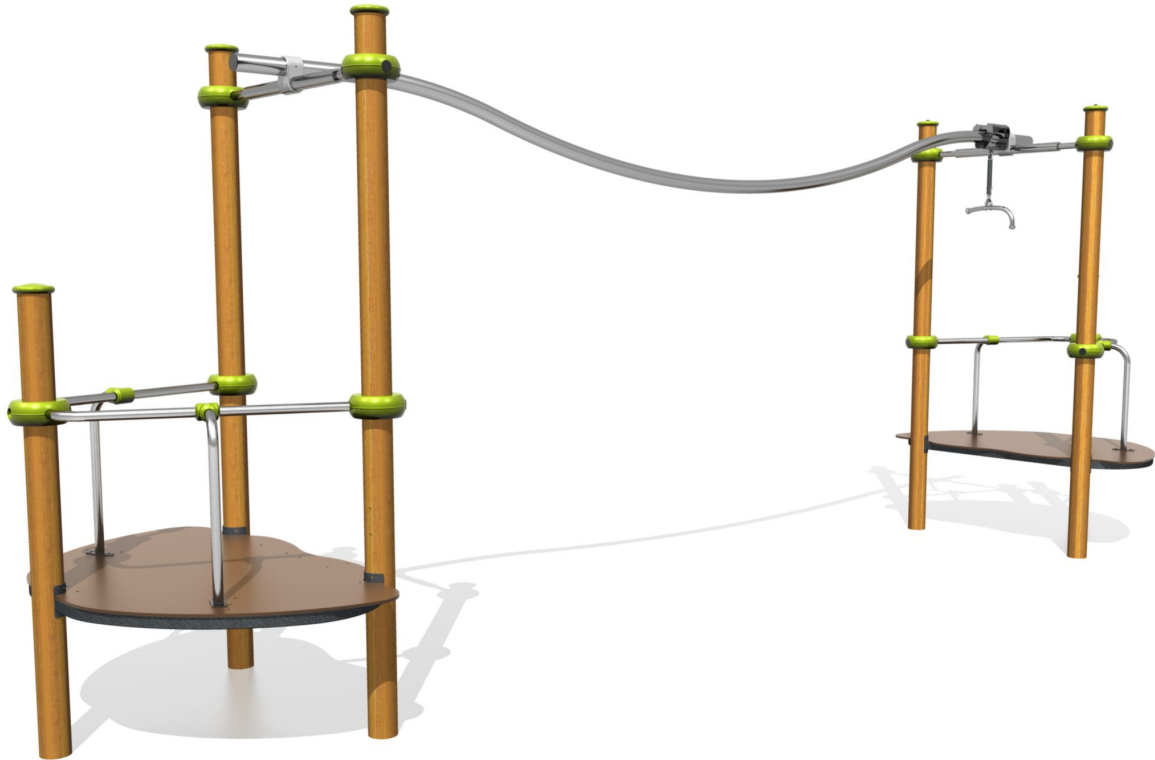

Play value

meeting / role play



sliding



climbing



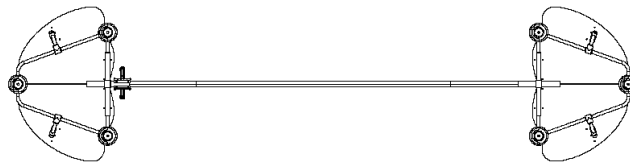



Installation of equipment

Impact area =

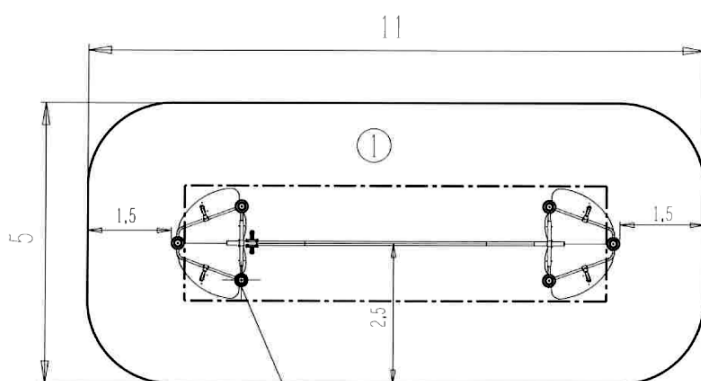
-  Impact area
-  Free space



Point de Référence
Setting Out Point
Punto de referencia
Bezugspunkt

		
1	1m	53,5m ²



2



10h00



0.29m³



52.5m²



371kg



38kg

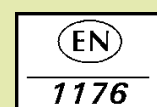

Proludic

2013-03-04